

Model No.: BDA1-060X11DG/EG

- Excellent PIM, -150dBc @ 1695 - 2700MHz
- Frequency range: 1695-2700, 3400-3800 and 4900-5900MHz
- Consistent patterns
- Connector options: 7/16 DIN, 4.3-10 and N type
- IP65 for both indoor and outdoor application

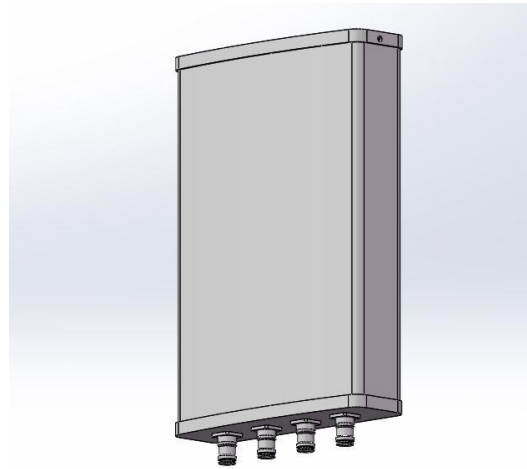

Product Specifications:

Electrical			
Frequency band, MHz	1695 - 2700	3400 - 3800	4900 - 5900
Horizontal beamwidth, degrees	60	60	60
Vertical beamwidth, degrees	20	20	20
Gain, dBi	12	11	11
Vertical sidelobe, dB	14		
PIM 3 rd @ 2*20W, dBc	-150	\	\
F/B ratio, dB	20		
Isolation, dB	20		
CPR @ boresight, dB	15		
VSWR/Return Loss, dB	1.5 / 14		
Impedance	50 ohm		
Polarization	± 45°		

Mechanical	
Mounting Type	Wall mount / Pole mount
Adjustable range for vertical	80 degrees
Adjustable range for horizontal	80 degrees(wall mount) / 360 degrees (pole mount)
Number of Ports, all types	4, 2 Ports for 1695-2700MHz, 2 Ports for 3400-3800/4900-5900MHz
Radome Color	Grey
Radome Material	PVC, UV resistant
Net size, Length*Width*Depth	415 * 285 * 85mm
Maximum Wind-loading	216 kph
IP protection	IP65
Net weight	~ 3 Kg
Operating Temperature	-40 °C to +60 °C (-40 °F to +140 °F)
Relative Humidity	0 to 100%

All specifications are subject to change without any notice. Please contact us for the latest information.

Patterns

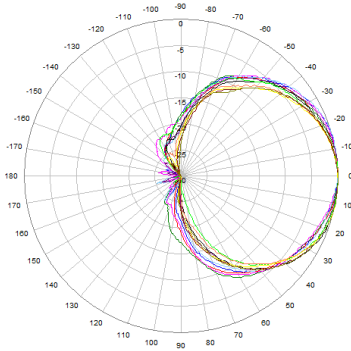

1695-2700MHz

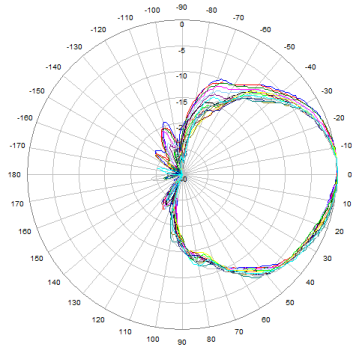

3400-3800MHz

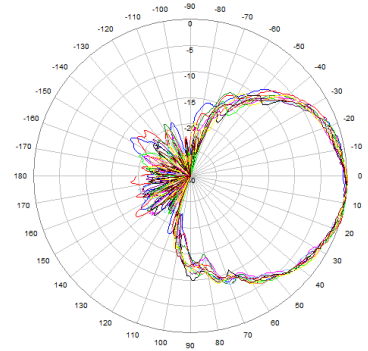

4900-5900MHz

Horizontal Beamwidth

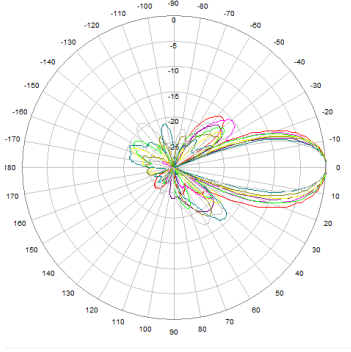

1695-2700MHz

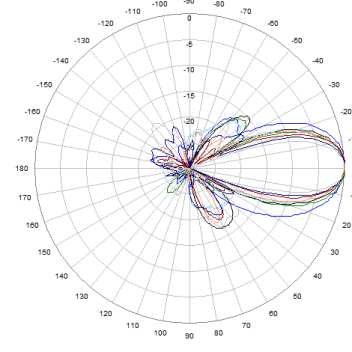

3400-3800MHz

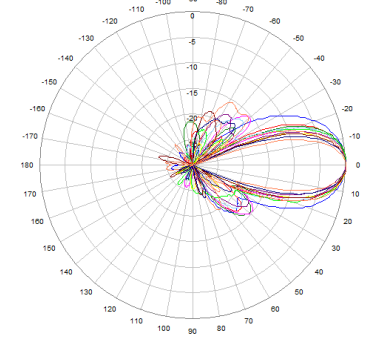

4900-5900MHz

Vertical Beamwidth